

BÄRO

Retail
Lighting

EC LUMINAIRE SERIES

Ontero
Intara
Pendiri





Ontero Intara Pendiro

- P. 04 **Overview**
EC luminaire series
- P. 06 **The squaring of the circle**
An interview with Jens Pattberg and
J. Manuel von Möller
- P. 08 **Ontero EC 125**
Surface-mounted luminaire
- P. 12 **Intara EC 125**
Semi-recessed luminaire
- P. 16 **Pendiro EC 125**
Suspended luminaire
- P. 20 **Decorative accessories**
Acrylic attachments, metal shades,
fabric shades
- P. 26 **Special light colours**
In the right light
- P. 30 **EC lighting technology**
Power ratings and light spectrums
- P. 41 **Product overview**
Variants and product numbers
- P. 46 **Service**
Your lighting partner. Right from the start.
Publishing details

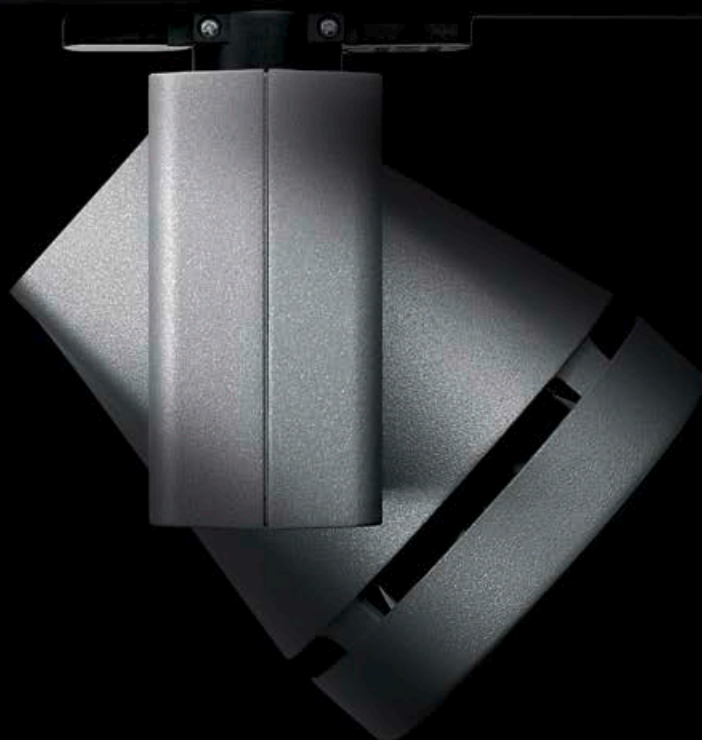

Outstanding efficiency
Highly efficient LED lighting technology combines perfectly coordinated system components with high-performance reflector technology.

Digital light control
All variants of the EC luminaire series can be integrated in a light control system with DALI. This enables creative, individually controllable light concepts to be implemented.

EC luminaire series

ONTERO, INTARA, PENDIRO

Ontero EC 125, Intara EC 125 and Pendirol EC 125 are innovative LED luminaires with a clear and consistent design idiom.

The luminaire series was specially developed for LED light sources. The luminaire heads are made of die-cast aluminium. Integrated cooling fins enable excellent thermal management which ensures optimum operating conditions for the lamps used and therefore a long life and high light quality.

The MIRO-SILVER® reflectors specially developed by BÄRO are extremely efficient in channelling light and have a very high level of efficiency. They combine excellent optical properties with maximum efficiency and direct the light to the target surface with barely any losses.



The squaring of the circle

An interview with designer Jens Pattberg and BÄRO CEO J. Manuel von Möller on the development of the EC luminaire series.

PHOTOGRAPHY: HARTMUT NÄGELE

Mr Pattberg, Mr von Möller, how has the cooperation been between BÄRO and brains4design? After all, this is already the third luminaire that you are realising together.

Jens Pattberg: We found that LED technology has not yet really played a major role in the field of design. And we discovered that when we really work intensively with this technology we come up with

new and innovative designs.

J. Manuel von Möller: It was important to me not to focus solely on appearance; the product also had to be well-equipped for the demands of everyday use. Anything else is neither in our interests nor in those of our customers. On the one hand we wanted to create a more delicate design idiom, but we were also aware of the technical challenges associated with the medium of

light: a certain amount of space is needed to accommodate the reflector, and you must deal with the heat so that there is no heat build-up. A luminaire must be 100% functional in all different kinds of ambient conditions – even on a hot summer's day.

Jens Pattberg: For example, we tried to integrate the cooling equipment directly in the housing and combined different materials for this. As a de-

signer, when I examine technologies intensively I can create new designs. This is why for me, concerning myself with new technologies forms the basis for developing innovative products. And it goes without saying that they must be well designed.



Does the design and development process for an LED luminaire differ from that for a conventional luminaire? The technology plays a much greater role, doesn't it?

Jens Pattberg: Now I'd say: No. When I look at our previous projects with reflector technology and housing structure, I studied the technology in the same depth as I do now with LED technology. For me as a designer it is particularly exciting that the use of LED technology offers us completely new opportunities. For example, if you fly to Asia in an A380, you notice how the colours of the light slowly become darker and redder – and in the morning a little bluer again. This shows that even unexpected markets can be served with LED technology in future.

What was the basic idea for the design of the EC luminaire series? And where were the greatest challenges?

Jens Pattberg: Right at the beginning of the cooperation we set ourselves the target of developing a design style that puts the focus on light and reduces and simplifies the product design idiom. This approach also formed the basis for developing the EC luminaire series. We wanted to translate complex technology into simple shapes and design elements.

J. Manuel von Möller: Right from the start our unusual request was to “square the circle”. We wanted a product that conveys high quality – in terms of material, look and feel. At the same time the product costs had to stay within reasonable limits. With the help of brains4design we reached an excellent solution: the EC luminaires – where the squaring of the circle has also

been achieved visually. The shape of the luminaire head changes from square at the top end to round where the light is emitted. There is barely any better metaphor for what we aimed to achieve with the EC series and have succeeded in doing.

What advantages does LED technology offer the retail sector?

Jens Pattberg: The most important advantage is energy efficiency and the potential savings in connection with this. The savings are so great that sooner or later everyone will have to invest in LED technology. Depending on the amount of time that such systems operate each day, the time needed to amortise the investment can vary, but ultimately no one will be able to avoid LED technology.

J. Manuel von Möller: And there is a further factor that is equally important: the reduced maintenance. LEDs have a much longer service life than conventional light sources. It goes without saying that this offers our customers huge advantages.

What role does the light colour play in product lighting – especially in lighting for fresh foodstuffs?

J. Manuel von Möller: We have concerned ourselves with this topic for decades. For example, we have had light colours specifically developed for us, tested them together with our customers, and regularly matched and perfected them – until we ultimately achieved the precise result desired by the customer. The ambience of a store is largely defined by being able to present different products in colours appropriate for them. But it is not only the light colour that is important – product preservation also plays a decisive role.



LED technology also offers advantages here. But I'd like to add something to the previous point: the cost savings and the efficiency advantages are very important aspects. But ultimately, it is being able to present a store and the products in such a way that the consumer feels comfortable there, enjoys going there and spending time there that offers retailers the biggest opportunities. And this is where there is further considerable potential – not just for LEDs, but for good lighting as a whole.

To what extent have the demands on good lighting changed? Are products presented differently nowadays?

Jens Pattberg: I believe that the better the lighting planner, the architect and the designer understand the opportunities offered by LED technology, the more the lighting will be integrated in the architecture. In the retail sector in particular the focus is less on the luminaire and much more on the light.

J. Manuel von Möller: Customers are not usually very interested in luminaires themselves – with the exception of spectacular unique luminaires as design highlights. They want excellent illumination producing the desired effect. Of course that presents us as a luminaire manufacturer with a challenge: on the one hand we want to offer an attractive product with state-of-the-art technology and design. And on the other hand we know that our products are first and foremost good when they can be perfectly integrated into the design concept of the store in question. This balancing act between highly efficient and unobtrusive functionality on the one hand and an elegant, filigree design on the other hand is easier to master with LEDs than with discharge lamps.

And finally, a hypothetical question: you aim to create the perfect light for every sales situation. Let's turn the tables. What is the perfect environment for BÄRO lighting systems?

J. Manuel von Möller: For us every environment that presents us with new challenges is good. Then we're in our element and we can showcase our knowledge and skills. For example, a challenge could be directing light to products from a great height, or dealing with different spatial dimensions within a building. Imagine that you have a transition from suspended ceilings to open, hall-like building structures within a premises. How do you manage to ensure that not only is the light evenly distributed, but also that the whole lighting system appears harmonious? This can be done very successfully with a luminaire family such as the EC series. You can cover some areas extremely well with the recessed luminaire, others with the surface-mounted luminaire and yet others with the suspended luminaire – all with a consistent design idiom.

Mr Pattberg, Mr von Möller, thank you for the interview.



Precise adjustment

The luminaires can be precisely adjusted for optimal alignment of the light cone. The pivot angle of the luminaire head is $\pm 105^\circ$, the swivelling range $\pm 175^\circ$. This enables light to be precisely directed to where you need it.

5 beam characteristics

2 rotation-symmetrical (Spot 20° , Flood 40°),
1 asymmetrical (OvalBasic $25^\circ \times 55^\circ$), 2 double asymmetrical (BatWing $2 \times 25^\circ$, $2 \times 35^\circ$).

Ontero EC 125

OUTSTANDING VERSATILITY

Ontero EC 125 is a multi-functional luminaire with a prize-winning design. The surface-mounted luminaire is pivoted and adjustable and can be moved as required, which means that it is suitable for almost all lighting tasks. The design of the luminaire, which is characterised by smooth transitions from round to angular elements, was awarded the iF design award.

Depending on the lighting situation and the desired lighting effect, Ontero EC 125 is available with various light colours and reflectors. State-of-the-art LED arrays and modern driver technology guarantee perfect light quality and very high efficiency. The luminaire is also available as a DALI version for integration in a light control system.



5 BEAM
CHARACTERISTICS:

- 2 ROTATION-SYMMETRICAL
(Spot 20°, Flood 40°)
- 1 ASYMMETRICAL
(OvalBasic 25° x 55°)
- 2 DOUBLE ASYMMETRICAL
(BatWing 2 x 25°, 2 x 35°)

Ontero EC 125

COLOUR CODE	927	830	835	840
Luminaire luminous flux [lm]	2,460	3,180	3,210	3,290
System wattage [W]	23	23	23	23

COLOUR SPECTRUM	PearlWhite	GoldenBread	Sun
Luminaire luminous flux [lm]	2,620	2,520	1,540
System wattage [W]	23	23	23

COLOUR SPECTRUM	Fish&Seafood	SpecialMeat
Luminaire luminous flux [lm]	1,700	1,440
System wattage [W]	23	23



- Available wattages:
23 W, 34 W, 41 W, 47 W (constant current/ DALI 100 % - 1 %) BatWing: 59 W, 78 W (constant current)
- The smallest available system wattages and the resulting luminaire luminous fluxes for Spot, Flood and OvalBasic reflectors are specified. The corresponding values for the BatWing reflector are shown on page 40.
- All data are typical values. The details of the luminous flux vary within a tolerance range of $\pm 10\%$. System features may change if product improvements are made due to technical advances.

Surface-mounted spotlight with LED, passive cooling (up to 59 W), chromaticity point tolerance 3 SDCM (initial), 2SDCM for 927, 830, 835, 840, PearlWhite (initial), 99.99% pure aluminium reflector in MIRO-SILVER®, spotlight pivoted, adjustable luminaire head, die cast aluminium luminaire housing, powder-coated, including glass cover, multi-adapter, luminaire colours strato black, strato silver, strato white, protection rating IP 20, protection class I, weight 2.1 kg

Luminaire body in RAL colours, filter discs and filter holder, chrome-plated (optional)

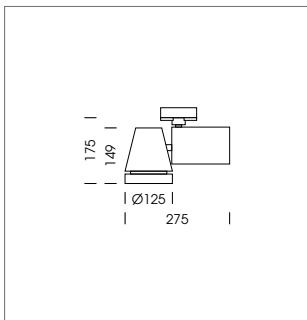

Further information and light distribution curves can be found from page 30 onwards





Maximum options

An installation depth of just 90 mm offers maximum freedom.

Light projection flush with the ceiling

The large angle of adjustment makes the luminaire ideal for accentuating decorations high up.

Intara EC 125

ELEGANTE FLEXIBILITY

The semi-recessed luminaire Intara EC 125 combines the low-key elegance of a recessed luminaire with the flexibility of a surface-mounted luminaire. It can be pivoted to such an extent that even the ceiling can be illuminated. It has a 65 degree angle of adjustment and a pivot angle of 170 degrees.

Like Ontero EC 125, Intara EC 125 is available with various light colours and reflectors. All models have a built-in lightproof housing. The separate driver unit is supplied with a feed-through wiring set.

3 BEAM
CHARACTERISTICS:

- 2 ROTATION-SYMMETRICAL
(Spot 20°, Flood 40°)
- 1 ASYMMETRICAL
(OvalBasic 25° x 55°)

Intara EC 125

COLOUR CODE	927	830	835	840
Luminaire luminous flux [lm]	2,460	3,180	3,210	3,290
System wattage [W]	23	23	23	23

COLOUR SPECTRUM	PearlWhite	GoldenBread	Sun
Luminaire luminous flux [lm]	2,620	2,520	1,540
System wattage [W]	23	23	23

COLOUR SPECTRUM	Fish&Seafood	SpecialMeat
Luminaire luminous flux [lm]	1,700	1,440
System wattage [W]	23	23



- Available wattages:
23 W, 34 W, 41 W, 47 W (constant current/DALI 100 % - 1 %)
- The smallest available system wattages and the resulting luminaire luminous fluxes for Spot, Flood and OvalBasic reflectors are specified.
- All data are typical values. The details of the luminous flux vary within a tolerance range of $\pm 10\%$. System features may change if product improvements are made due to technical advances.

Semi-recessed luminaire with LED, passive cooling, chromaticity point tolerance 3 SDCM (initial), 2 SDCM for 927, 830, 835, 840, PearlWhite (initial), reflector 99.99% pure aluminium in MIRO-SILVER®, infinitely adjustable and pivotable luminaire head, built-in sheet steel housing, lightproof, die-cast aluminium luminaire head, powder coated, including glass cover, separate driver unit, luminaire colours strato black, silver, white, protection rating IP 20, protection class I, weight 2.0 kg

Luminaire body in RAL colours, filter discs and filter holder chrome-plated (optional)

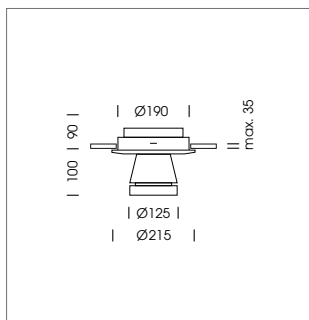

Further information and light distribution curves can be found from page 30 onwards





Decorative eye-catcher
A range of decorative attachments are available with different shapes, colours and materials for adding individual highlights.

3 attachment options
Recessed canopy, surface-mounted canopy, track canopy.

Pendiro EC 125

A MASTER OF TRANSFORMATION

Pendiro EC 125 is particularly suited to adding accents in shop fitting concepts. The luminaire is suspended from two thin cables which also supply the electricity, making a separate supply cable superfluous. What's more, a special control mechanism prevents the luminaire head from twisting.

Depending on the type of premises in question, Pendiro EC 125 can be attached either with a canopy for mounting in or on ceilings or on a track. If an eye-catching, decorative lighting solution is desired, the luminaire can be fitted with various attachments and shades without the need for tools.

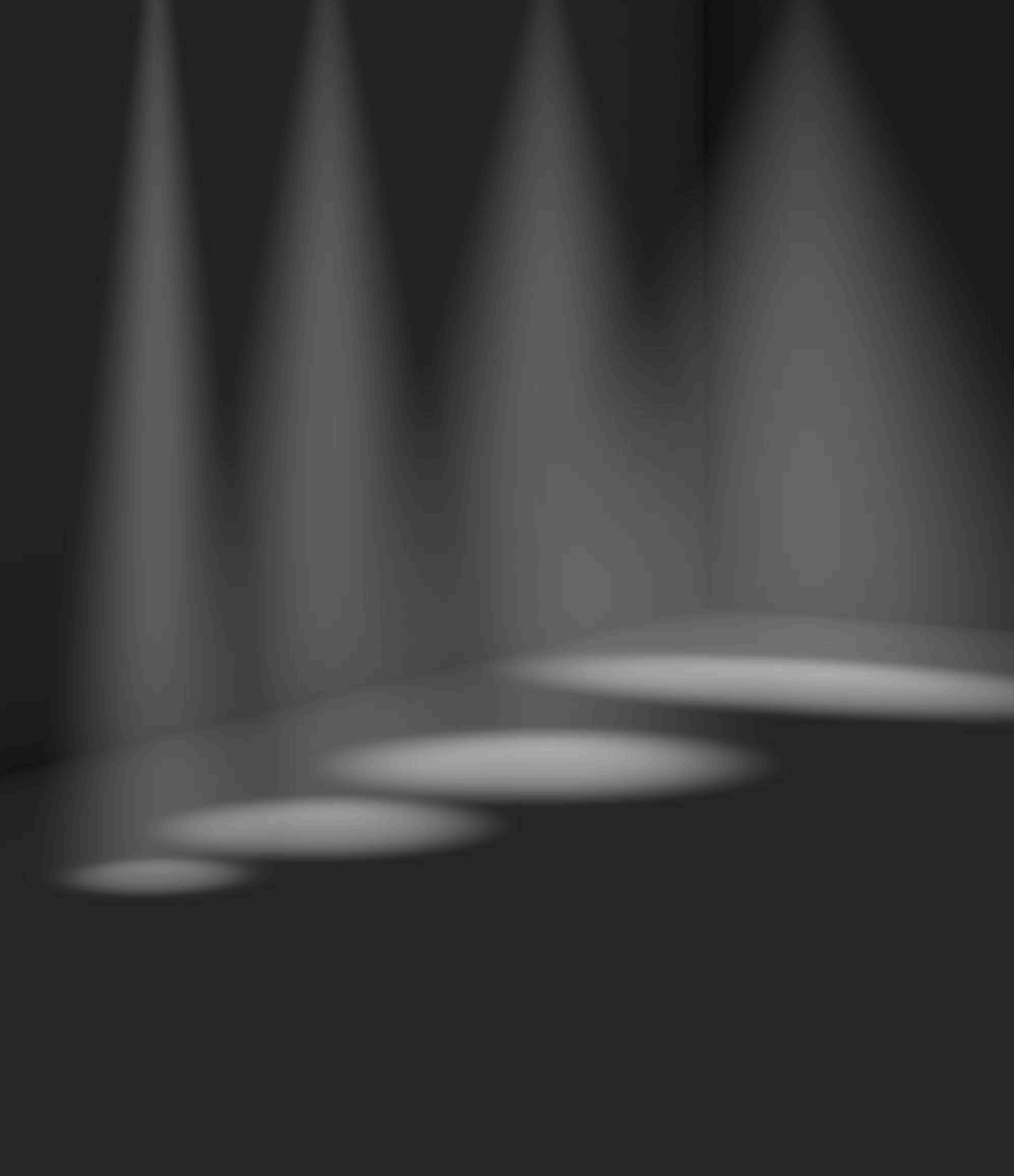

3 BEAM
CHARACTERISTICS:

- 2 ROTATION-SYMMETRICAL
(Spot 20°, Flood 40°)
- 1 ASYMMETRICAL
(OvalBasic 25° x 55°)

Pendiro EC 125

COLOUR CODE	927	830	835	840
Luminaire luminous flux [lm]	2,460	3,180	3,210	3,290
System wattage [W]	23	23	23	23

COLOUR SPECTRUM	PearlWhite	GoldenBread	Sun
Luminaire luminous flux [lm]	2,620	2,520	1,540
System wattage [W]	23	23	23

COLOUR SPECTRUM	Fish&Seafood	SpecialMeat
Luminaire luminous flux [lm]	1,700	1,440
System wattage [W]	23	23



- Available wattages:
23 W, 34 W, 41 W (constant current / DALI 100% – 1%)
- The smallest available system wattages and the resulting luminaire luminous fluxes for Spot, Flood and OvalBasic reflectors are specified.
- All data are typical values. The details of the luminous flux vary within a tolerance range of $\pm 10\%$. System features may change if product improvements are made due to technical advances.

Suspended luminaire with LED, passive cooling, chromaticity point tolerance 3 SDCM (initial), 2 SDCM for 927, 830, 835, 840, PearlWhite (initial), 99.99% pure aluminium reflector in MIRO-SILVER®, die-cast aluminium luminaire head, powder coated, including glass cover, power supply via suspension cables, luminaire colours strato black, strato silver, strato white, protection rating IP 20, protection class I, weight 2.1 kg

Decorative cylinder, decorative metal and fabric shades (optional)

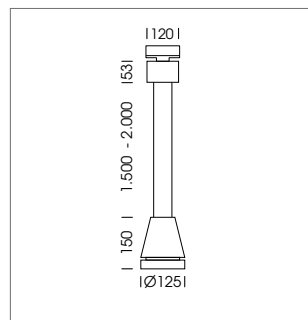
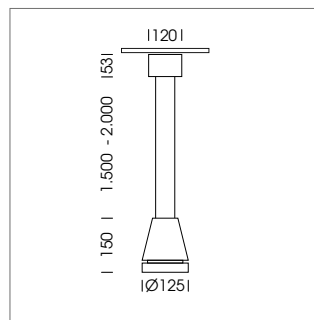
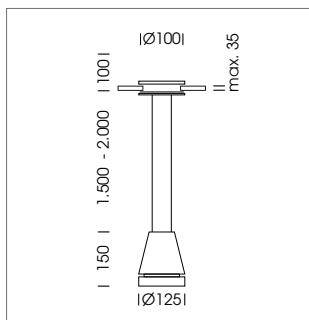

Decorative accessories can be found from page 20 onwards; further information and light distribution curves can be found from page 30 onwards





Decorative accessories

ACRYLIC ATTACHMENTS, METAL SHADES, FABRIC SHADES

Various shades and attachments supplement the suspended luminaires from BÄRO and expand the design scope for lighting projects in the retail sector.

There is a choice of satined, translucent acrylic attachments, retro-look metal shades made of aluminium, steel or sheet steel and fabric shades made of smooth chintz, which can be customised in terms of shape and colour.

Pendiro EC 125

Acrylic attachments

ACRYLIC ATTACHMENT

Attachment short
Material acrylic
Dimensions 130 x 3 x 60 mm
Weight approx. 0.3 Kg

Colour translucent

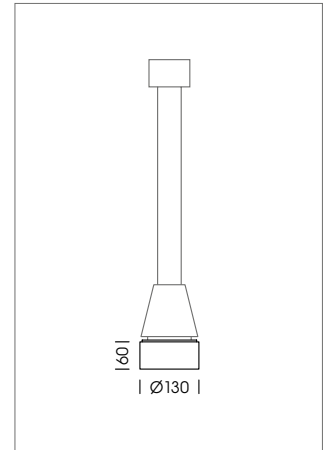

ACRYLIC ATTACHMENT

Attachment long
Material acrylic
Dimensions 130 x 3 x 120 mm
Weight approx. 0.4 Kg

Colour translucent

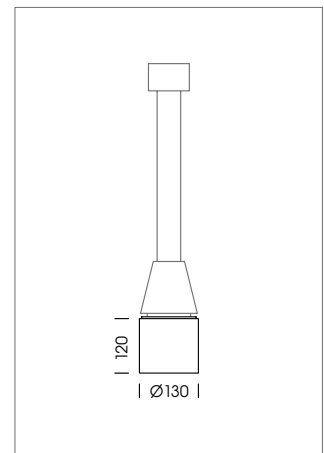

Please request the product number of your individual luminaire shade or attachment.

Pendiro EC 125

Metal shades

SHADE

Material aluminium
 Dimensions 314 x 134 x 181 mm
 Weight approx. 0.4 Kg

Inside colour Painted white
 Outside colour
 · Strato black
 · Strato silver
 · Strato white powder-coated
 · RAL and NCS colours on request
 · Surface alloys
 Copper . Chrome . Gold
 Copper, burnished . Nickel, matt . Brass, old

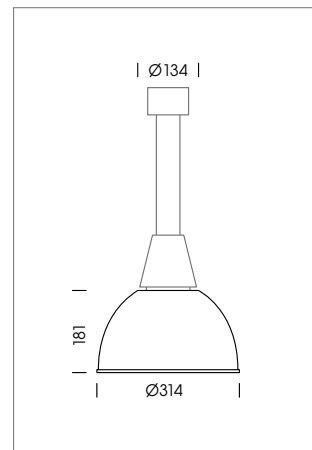

SHADE

Material aluminium
 Dimensions 240 x 142 x 120 mm
 Weight approx. 0.4 Kg

Inside colour Painted white
 Outside colour
 · Strato black
 · Strato silver
 · Strato white powder-coated
 · RAL and NCS colours on request
 · Surface alloys
 Copper . Chrome . Gold
 Copper, burnished . Nickel, matt . Brass, old

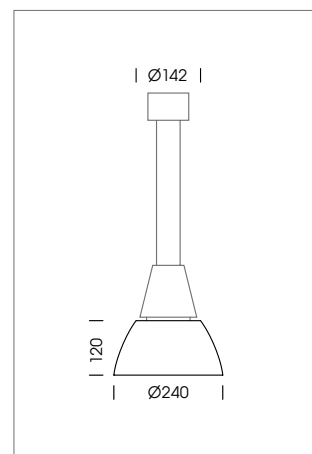

SHADE

Material Sheet steel
 Dimensions 445 x 186 x 145 mm
 Weight approx. 0.7 Kg

Inside colour Painted white
 Outside colour
 · Strato black
 · Strato silver
 · Strato white powder-coated
 · RAL and NCS colours on request
 · Surface alloys
 Copper . Chrome . Gold
 Copper, burnished . Nickel, matt . Brass, old

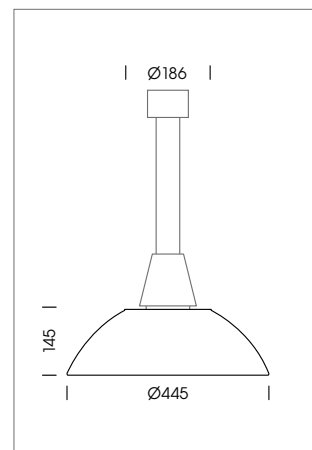

Please request the product number of your individual luminaire shade or attachment.

Pendiro EC 125

Fabric shades

SHADE

Material Chintz
Dimensions 300 x 160 x 140 mm
Weight approx. 0.2 Kg
Inside colour White laminated plastic
Outside colour Chintz in line with colour sample

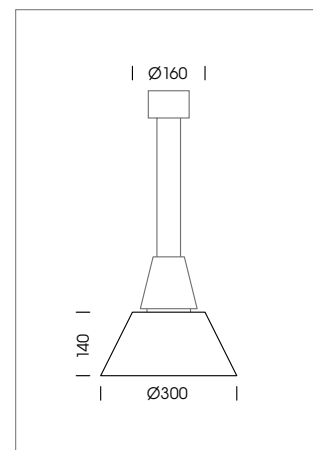

SHADE

Material Chintz
Dimensions 210 x 160 x 140 mm
Weight approx. 0.2 Kg
Inside colour White laminated plastic
Outside colour Chintz in line with colour sample

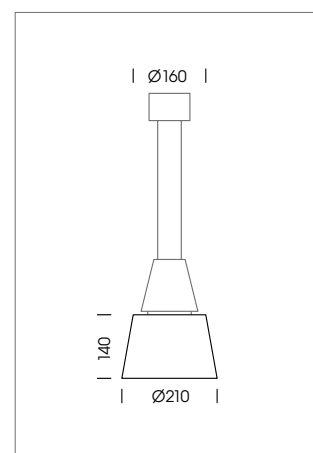

SHADE

Material Chintz
Dimensions 160 x 160 x 140 mm
Weight approx. 0.2 Kg
Inside colour White laminated plastic
Outside colour Chintz in line with colour sample

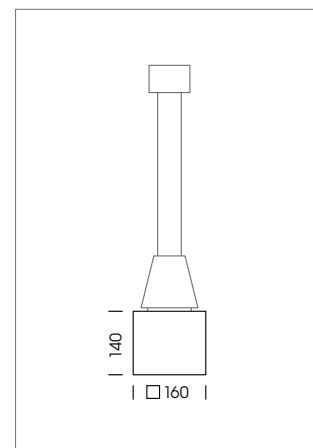

Please request the product number of your individual luminaire shade or attachment.



In the right light

SPECIAL LIGHT COLOURS

Light that optimises the natural colours of products is one of the most effective, but also one of the most sophisticated tools of retail lighting. Thanks to decades of experience BÄRO has the corresponding products, technologies and the expertise needed.

Light creates an atmosphere – and it supports the sales-promoting presentation of all kinds of products. From fresh foodstuffs to non-food products, fashion and leisure articles – lighting with a coordinated spectral composition can render the colour, material and surface properties of products in a way that shows them off to best advantage to customers. Successful sales-promoting lighting therefore deliberately engages with expectations and visual habits – and triggers positive associations.

For example, you see a ripe red apple in the fruit display. Its colour impression depends on several factors at this moment: an artificial light source illuminates the apple with white light with a certain spectral composition, which rarely corresponds to the continuous spectrum of sunlight. On the other hand the surface of the apple absorbs part of this light spectrum while reflecting other components of the

light. These catch the eye where sensory cells measure the blue, green and red components of the light and convey them to the visual centre of the brain: ultimately, a subjective colour impression is created.

As not the whole spectrum, but rather just three selective colour bands are measured and processed by the brain, the metamerism phenomenon occurs: light with a different composition can produce the same colour impression for the viewer – and body colours that looked the same under certain lighting may differ greatly under different light.

For product illumination this means: if artificially influenced, the perception of certain colour shades typical to products can be changed in a surprisingly wide range. Depending on the lighting the red of the apple can appear warmer or cooler,

more or less saturated. The art of product lighting that optimises the products' own colours is to use light spectrums tailored to different applications. BÄRO has been a trailblazer in this art for many years.

As far back as 50 years ago BÄRO used PAR lamps with special coatings and later high-pressure discharge lamps with special glass filters holding back defined spectral components for one of the most popular applications for light optimising natural colours: the illumination of fresh meat and sausage products. This "SpecialMeat" light optimised the red and pink colours of the products so that they were shown to much better advantage than under the simple fluorescent lamps that standard at that time.

Even this pioneering application shows that lighting that optimises the inherent colours of products is always a balancing act:



"LED technology offers numerous starting points for defining light spectrums."

On the one hand traders and customers want to achieve an inviting product presentation, but this must never cross the line into falsifying or masking the products – a question of sensitivity and experience which BÄRO has acquired over many years.

Lamps and filters are now largely a thing of the past – BÄRO now exclusively develops LED luminaires and also has methods of producing light spectrums with this technology that optimise the natural colours of products. The prerequisites for this are good as LED technology offers numerous starting points for defining light spectrums. Standard white LEDs always initially produce blue light that is partly converted into other wavelengths through a phosphor coating. The mix creates white light. The choice of semi-conductor materials, the composition of the phosphors and, if applicable, the combination with coloured LEDs result in customised spectrums.

BÄRO works closely with technology partners to offer its customers an extensive range of standard and special light colours tailored to individual needs. For BÄRO the standard light colours are the white tones that are oriented to the "Planck curve" and are described with standard specification of the light colour number or the colour temperature in Kelvin. Here BÄRO already offers a wider range than usual ranging from warm white (2,700 K) to 3,000 K and 3,500 K and neutral white (4,000K). Customers can choose between excellent colour rendering quality with $R(a) > 90$ or slightly higher luminous efficacy yet still with good colour rendering quality $R(a) > 80$ as a particularly efficient solution in non-critical applications.

In addition to these standard light colours there are special light colours: LED modules where the spectrums and chromaticity points are not oriented to the Planck curve. They cannot be defined with standard specification of the colour temperature and colour rendering index, but rather by their respective practical application. In addition to well-proven classics such as "SpecialMeat" for meat and sausage products or "Sun" for fruit and vegetables BÄRO is constantly researching new special light colours that take account of current technologies and market needs.

The light spectrum

Visible light is the small part of electromagnetic radiation that the human eye is able to see without technical aids.

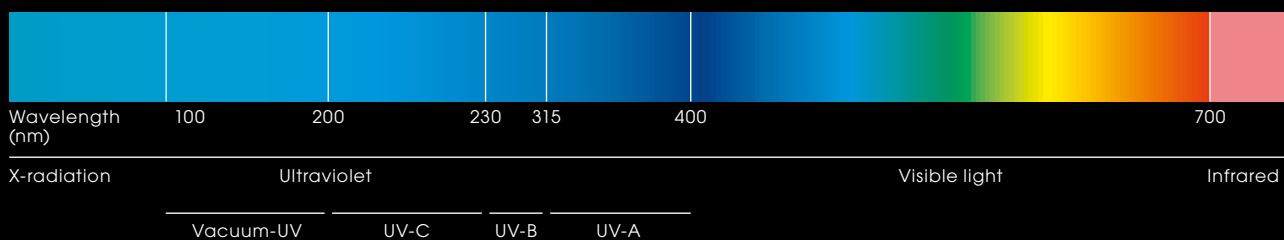

OVERVIEW OF THE AVAILABLE LIGHT COLOURS

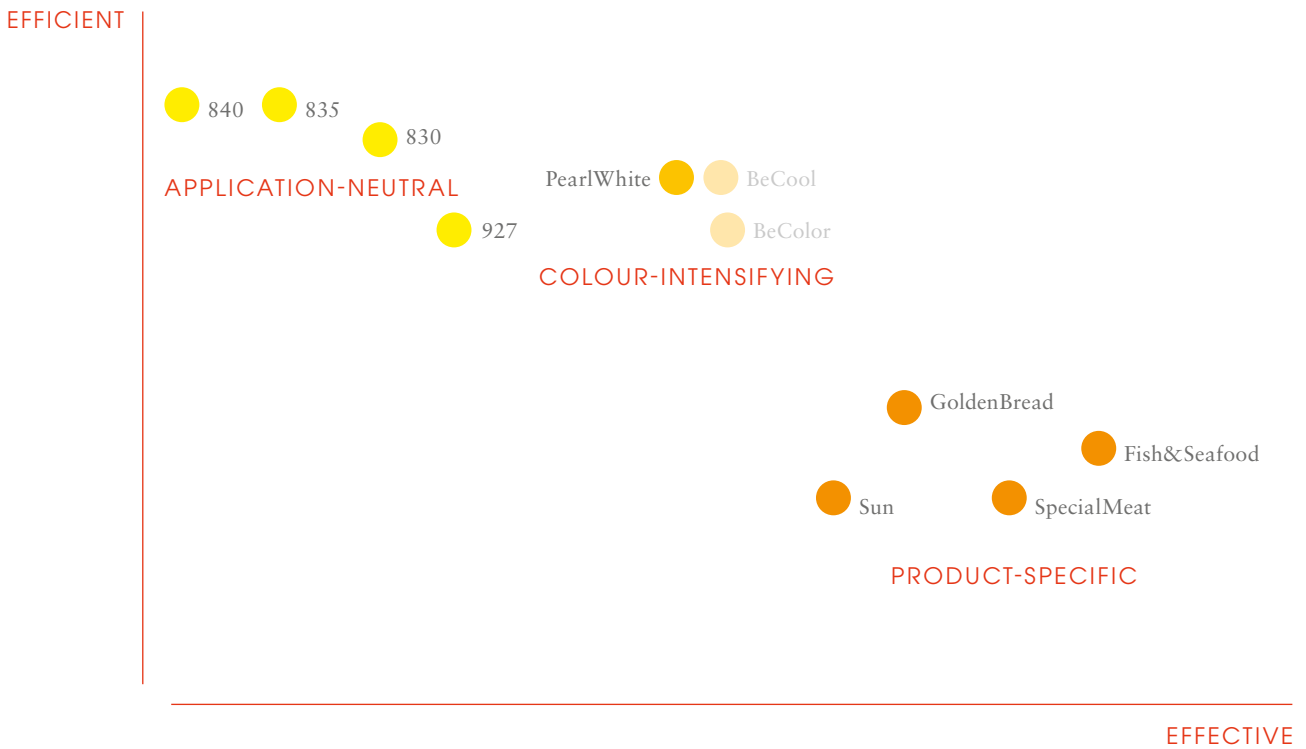

The selection of the right light colour is always a balance between maximum efficiency and optimum product presentation

- Standard light colours with neutral colour rendering
- Special light colours with higher colour saturation (for EC only PearlWhite)
- Special light colours with an application-specific colour spectrum

Do not hesitate to contact BÄRO and take advantage of the company's expertise and experience if you would like to use light with a product-specific lighting effect in your projects as a retailer, retail designer or lighting planner. Our experts will be pleased to advise you – from the design to detailed planning, installation and alignment of the luminaires.

EC lighting technology

POWER RATINGS AND LIGHT SPECTRUMS

Depending on the application and the light planning requirements, different lighting technologies can be chosen.

Different reflector types are available for these LED models: spot reflectors are predestined for accent lighting, flood reflectors are suitable both for illuminating larger surfaces and for general lighting. Thanks to their oval light distribution pattern OvalBasic reflectors enable particularly effective illumination of product presentations, while BatWing reflectors are ideal for the efficient lighting of aisles.

In addition to the standard light colours the luminaires are also available in special light colours for the natural illumination of fresh foodstuffs with optimisation of their inherent colours.

927

Colour code

The warm white LED spectrum of the standard light colour is ideal for illuminating goods and product types with warm colours and for creating a harmonious atmosphere. The very good colour rendering gives the surfaces a high-quality appearance and even the smallest colour nuances are clearly apparent.

REFLECTORS

WATTAGES

23W 34W 41W 47W

SPOT

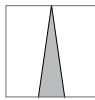
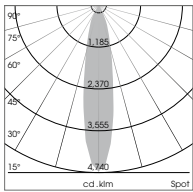

Luminaire luminous flux [lm]
Luminous efficacy [lm/W]

2,460 3,270 3,850 4,250
106 96 93 90

Illuminance [lx]

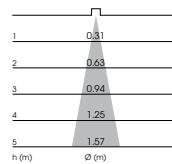

1	0.31	14,857	19,749	23,252	25,667
2	0.63	3,714	4,937	5,813	6,417
3	0.94	1,651	2,194	2,584	2,852
4	1.25	929	1,234	1,453	1,604
5	1.57	594	790	930	1,027

FLOOD

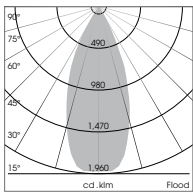

Luminaire luminous flux [lm]
Luminous efficacy [lm/W]

2,460 3,270 3,850 4,250
106 96 93 90

Illuminance [lx]

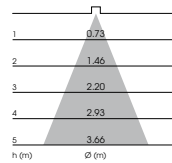

1	0.73	4,885	6,493	7,645	8,439
2	1.46	1,221	1,623	1,911	2,110
3	2.20	543	721	849	938
4	2.93	305	406	478	527
5	3.66	195	260	306	338

OVALBASIC

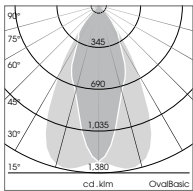

Luminaire luminous flux [lm]
Luminous efficacy [lm/W]

2,460 3,270 3,850 4,250
106 96 93 90

Illuminance [lx]

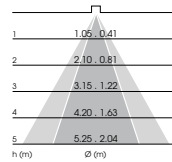

1	1.05, 0.41	3,831	5,092	5,995	6,618
2	2.10, 0.81	958	1,273	1,499	1,654
3	3.15, 1.22	426	566	666	735
4	4.20, 1.63	239	318	375	414
5	5.25, 2.04	153	204	240	265

For more technical details about the individual luminaires, please see our datasheets available at www.baero.com. The luminaire luminous flux figures vary in a tolerance range of ± 10%. All data are typical values. System features may change if product improvements are made due to technical advances. Errors excepted.

830

Colour code

The warm white LED spectrum of the standard light colour is primarily used for efficient lighting when consistent good colour rendering of the colours is desired for all objects illuminated.

REFLECTORS

WATTAGES

23W

34W

41W

47W

SPOT

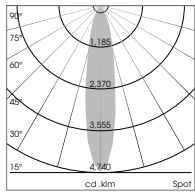

Luminaire luminous flux [lm]
Luminous efficacy [lm/W]

3,180 4,230 4,970 5,480
138 124 121 116

Illuminance [lx]

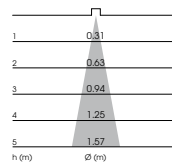

h (m)	ø (m)	23W	34W	41W	47W
1	0.31	19,205	25,547	30,016	33,096
2	0.63	4,801	6,387	7,504	8,274
3	0.94	2,134	2,839	3,335	3,677
4	1.25	1,200	1,597	1,876	2,068
5	1.57	768	1,022	1,201	1,324

FLOOD

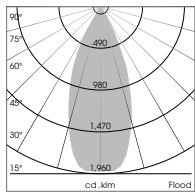

Luminaire luminous flux [lm]
Luminous efficacy [lm/W]

3,180 4,230 4,970 5,480
138 124 121 116

Illuminance [lx]

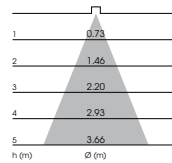

h (m)	ø (m)	23W	34W	41W	47W
1	0.73	6,314	8,399	9,868	10,881
2	1.46	1,579	2,100	2,467	2,720
3	2.20	702	933	1,096	1,209
4	2.93	395	525	617	680
5	3.66	253	336	395	435

OVALBASIC

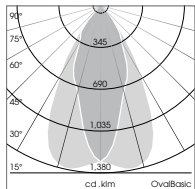

Luminaire luminous flux [lm]
Luminous efficacy [lm/W]

3,180 4,230 4,970 5,480
138 124 121 116

Illuminance [lx]

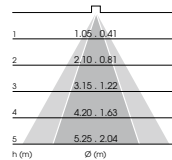

h (m)	ø (m)	23W	34W	41W	47W
1	1.05 0.41	4,952	6,587	7,739	8,533
2	2.10 0.81	1,238	1,647	1,935	2,133
3	3.15 1.22	550	732	860	948
4	4.20 1.63	309	412	484	533
5	5.25 2.04	198	263	310	341

For more technical details about the individual luminaires, please see our datasheets available at www.baero.com. The luminaire luminous flux figures vary in a tolerance range of $\pm 10\%$. All data are typical values. System features may change if product improvements are made due to technical advances. Errors excepted.

835

Colour code

The LED spectrum of the standard light colour is between neutral white and warm white and is suitable for use wherever the aim is to efficiently showcase products with an emphasis on their fresh colours or to create a corresponding spatial atmosphere.

REFLECTORS

WATTAGES

23W 34W 41W 47W

SPOT

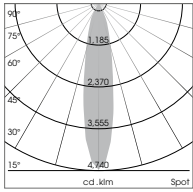

Luminaire luminous flux [lm]
Luminous efficacy [lm/W]

3,210 4,260 5,010 5,520
139 125 122 117

Illuminance [lx]

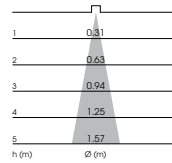

h (m)	Ø (m)	23W	34W	41W	47W
1	0.31	19,386	25,728	30,257	33,337
2	0.63	4,847	6,432	7,564	8,334
3	0.94	2,154	2,859	3,362	3,704
4	1.25	1,212	1,608	1,891	2,084
5	1.57	775	1,029	1,210	1,333

FLOOD

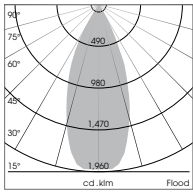

Luminaire luminous flux [lm]
Luminous efficacy [lm/W]

3,210 4,260 5,010 5,520
139 125 122 117

Illuminance [lx]

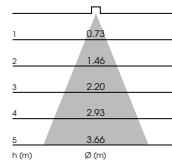

h (m)	Ø (m)	23W	34W	41W	47W
1	0.73	6,374	8,459	9,948	10,961
2	1.46	1,593	2,115	2,487	2,740
3	2.20	708	940	1,105	1,218
4	2.93	398	529	622	685
5	3.66	255	338	398	438

OVALBASIC

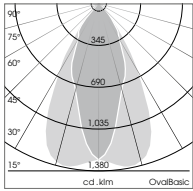

Luminaire luminous flux [lm]
Luminous efficacy [lm/W]

3,210 4,260 5,010 5,520
139 125 122 117

Illuminance [lx]

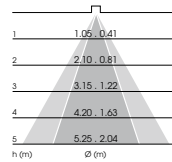

h (m)	Ø (m)	23W	34W	41W	47W
1	1.05, 0.41	4,998	6,634	7,801	8,596
2	2.10, 0.81	1,250	1,658	1,950	2,149
3	3.15, 1.22	555	737	867	955
4	4.20, 1.63	312	415	488	537
5	5.25, 2.04	200	265	312	344

For more technical details about the individual luminaires, please see our datasheets available at www.baero.com. The luminaire luminous flux figures vary in a tolerance range of ± 10%. All data are typical values. System features may change if product improvements are made due to technical advances. Errors excepted.

840

Colour code

As a standard light colour the neutral white LED spectrum is suitable for the efficient illumination of clear body colours or to create a cooler spatial impression.

REFLECTORS

WATTAGES

23 W

34 W

41 W

47 W

SPOT

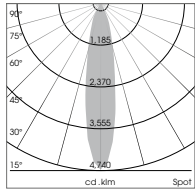

Luminaire luminous flux [lm]
Luminous efficacy [lm/W]

Illuminance [lx]

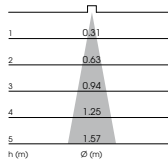

	23 W	34 W	41 W	47 W
Luminaire luminous flux [lm]	3,290	4,370	5,610	6,270
Luminous efficacy [lm/W]	143	128	137	133
Illuminance [lx]				
1	19,870	26,392	26,557	29,681
2	4,967	6,598	6,639	7,420
3	2,208	2,932	2,951	3,298
4	1,242	1,650	1,660	1,855
5	795	1,056	1,062	1,187

FLOOD

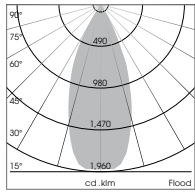

Luminaire luminous flux [lm]
Luminous efficacy [lm/W]

Illuminance [lx]

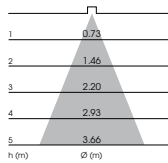

	23 W	34 W	41 W	47 W
Luminaire luminous flux [lm]	3,290	4,370	5,610	6,270
Luminous efficacy [lm/W]	143	128	137	133
Illuminance [lx]				
1	6,533	8,677	10,853	12,130
2	1,633	2,169	2,713	3,033
3	726	964	1,206	1,348
4	408	542	678	758
5	261	347	434	485

OVALBASIC

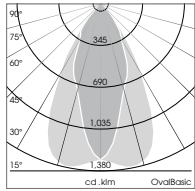

Luminaire luminous flux [lm]
Luminous efficacy [lm/W]

Illuminance [lx]

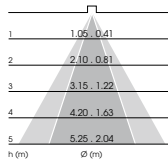

	23 W	34 W	41 W	47 W
Luminaire luminous flux [lm]	3,290	4,370	5,610	6,270
Luminous efficacy [lm/W]	143	128	137	133
Illuminance [lx]				
1	5,123	6,805	7,234	8,085
2	1,281	1,701	1,809	2,021
3	569	756	804	898
4	320	425	452	505
5	205	272	289	323

For more technical details about the individual luminaires, please see our datasheets available at www.baero.com. The luminaire luminous flux figures vary in a tolerance range of $\pm 10\%$. All data are typical values. System features may change if product improvements are made due to technical advances. Errors excepted.

PearlWhite

Colour spectrum

The LED spectrum of the special light colour is below black body. It has a colour-intensifying effect and creates an elegant atmosphere in the room. The correlated colour temperature is 3,100 K.

REFLECTORS

WATTAGES

23 W 34 W 41 W 47 W

SPOT

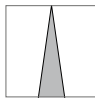
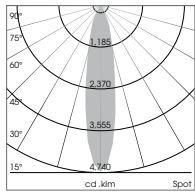

Luminaire luminous flux [lm]
Luminous efficacy [lm/W]

2,620 3,480 4,060 4,450
113 102 99 94

Illuminance [lx]

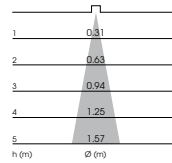

h (m)	Ø (m)	23 W	34 W	41 W	47 W
1	0.31	15,823	21,017	24,520	26,875
2	0.63	3,956	5,254	6,130	6,719
3	0.94	1,758	2,335	2,724	2,986
4	1.25	989	1,314	1,532	1,680
5	1.57	633	841	981	1,075

FLOOD

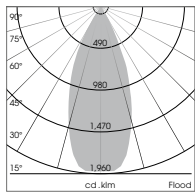

Luminaire luminous flux [lm]
Luminous efficacy [lm/W]

2,620 3,480 4,060 4,450
113 102 99 94

Illuminance [lx]

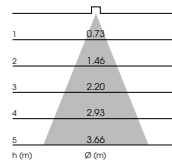

h (m)	Ø (m)	23 W	34 W	41 W	47 W
1	0.73	5,202	6,910	8,062	8,836
2	1.46	1,301	1,727	2,015	2,209
3	2.20	578	768	896	982
4	2.93	325	432	504	552
5	3.66	208	276	322	353

OVALBASIC

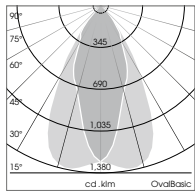

Luminaire luminous flux [lm]
Luminous efficacy [lm/W]

2,620 3,480 4,060 4,450
113 102 99 94

Illuminance [lx]

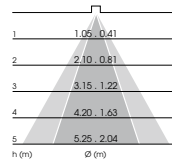

h (m)	Ø (m)	23 W	34 W	41 W	47 W
1	1.05	4,080	5,419	6,322	6,929
2	2.10	1,020	1,355	1,581	1,732
3	3.15	453	602	702	770
4	4.20	255	339	395	433
5	5.25	163	217	253	277

For more technical details about the individual luminaires, please see our datasheets available at www.baero.com. The luminaire luminous flux figures vary in a tolerance range of ± 10%. All data are typical values. System features may change if product improvements are made due to technical advances. Errors excepted.

GoldenBread

Colour spectrum

GoldenBread is among the product-specific LED spectrums with a correlated colour temperature of 2,500 K. In particular it produces a saturated rendering of rich golden-brown colours. The spectrum is ideal for illuminating fresh bread and bakery products.

REFLECTORS

WATTAGES

23 W

34 W

41 W

47 W

SPOT

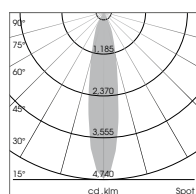

Luminaire luminous flux [lm]
Luminous efficacy [lm/W]

	23 W	34 W	41 W	47 W
Luminaire luminous flux [lm]	2,520	3,370	3,970	4,370
Luminous efficacy [lm/W]	110	99	97	93

Illuminance [lx]

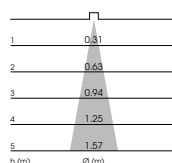

h (m)	Ø (m)	23 W	34 W	41 W	47 W
1	0.31	15,219	20,353	23,976	26,392
2	0.63	3,805	5,088	5,994	6,598
3	0.94	1,691	2,261	2,664	2,932
4	1.25	951	1,272	1,499	1,650
5	1.57	609	814	959	1,056

FLOOD

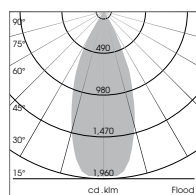

Luminaire luminous flux [lm]
Luminous efficacy [lm/W]

	23 W	34 W	3,970	4,370
Luminaire luminous flux [lm]	2,520	3,370	3,970	4,370
Luminous efficacy [lm/W]	110	99	97	93

Illuminance [lx]

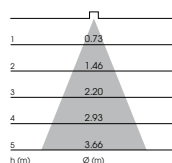

h (m)	Ø (m)	23 W	34 W	41 W	47 W
1	0.73	5,004	6,691	7,883	8,677
2	1.46	1,251	1,673	1,971	2,169
3	2.20	556	743	876	964
4	2.93	313	418	493	542
5	3.66	200	268	315	347

OVALBASIC

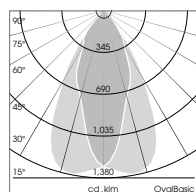

Luminaire luminous flux [lm]
Luminous efficacy [lm/W]

	23 W	34 W	3,970	4,370
Luminaire luminous flux [lm]	2,520	3,370	3,970	4,370
Luminous efficacy [lm/W]	110	99	97	93

Illuminance [lx]

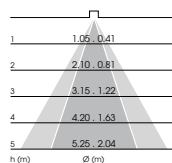

h (m)	Ø (m)	23 W	34 W	41 W	47 W
1	1.05	3,924	5,248	6,182	6,805
2	2.10	981	1,312	1,545	1,701
3	3.15	436	583	687	756
4	4.20	245	328	386	425
5	5.25	157	210	247	272

Sun

Colour spectrum

Sun intensifies all warm colours. The LED spectrum of the special light colour is both colour saturating and product specific and its optimal application is the illumination of fresh fruit and vegetables or in comparable non-food sectors. The correlated colour temperature is 2,400 K.

REFLECTORS

WATTAGES

23W

34W

41W

47W

SPOT

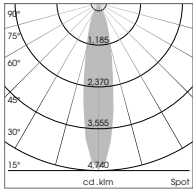

Luminaire luminous flux [lm]
Luminous efficacy [lm/W]

1,540	1,990	2,280	2,450
67	59	57	52

Illuminance [lx]

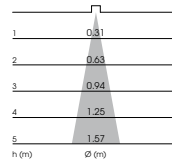

1	0.31	9,301	12,018	13,770	14,797
2	0.63	2,325	3,005	3,442	3,699
3	0.94	1,033	1,335	1,530	1,644
4	1.25	581	751	861	925
5	1.57	372	481	551	592

FLOOD

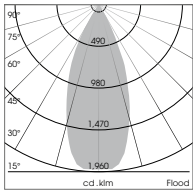

Luminaire luminous flux [lm]
Luminous efficacy [lm/W]

1,540	1,990	2,280	2,450
67	59	57	52

Illuminance [lx]

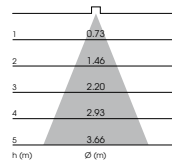

1	0.73	3,058	3,951	4,527	4,865
2	1.46	764	988	1,132	1,216
3	2.20	340	439	503	541
4	2.93	191	247	283	304
5	3.66	122	158	181	195

OVALBASIC

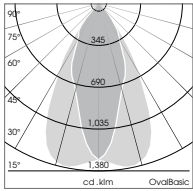

Luminaire luminous flux [lm]
Luminous efficacy [lm/W]

1,540	1,990	2,280	2,450
67	59	57	52

Illuminance [lx]

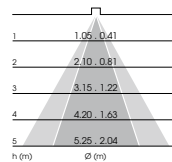

1	1.05, 0.41	2,398	3,099	3,550	3,815
2	2.10, 0.81	600	775	888	954
3	3.15, 1.22	266	344	394	424
4	4.20, 1.63	150	194	222	238
5	5.25, 2.04	96	124	142	153

For more technical details about the individual luminaires, please see our datasheets available at www.baero.com. The luminaire luminous flux figures vary in a tolerance range of ± 10%. All data are typical values. System features may change if product improvements are made due to technical advances. Errors excepted.

Fish&Seafood

Colour spectrum

Fish&Seafood is among the product-specific LED spectrums with a correlated colour temperature of 4,020 K. The chromaticity point is specially coordinated to the presentation of seafood. Due to the high red component this special light colour is also suited to the illumination of fresh meat and cold cuts.

REFLECTORS

WATTAGES

23 W

34 W

41 W

47 W

SPOT

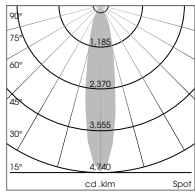

Luminaire luminous flux [lm]
Luminous efficacy [lm/W]

23 W	34 W	41 W	47 W
1,700	2,270	2,900	3,240
73	66	71	69

Illuminance [lx]

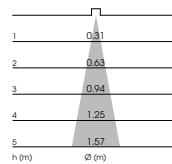

h (m)	Ø (m)	23 W	34 W	41 W	47 W
1	0.31	10,267	13,709	13,728	15,338
2	0.63	2,567	3,427	3,432	3,834
3	0.94	1,141	1,523	1,525	1,704
4	1.25	642	857	858	959
5	1.57	411	548	549	614

FLOOD

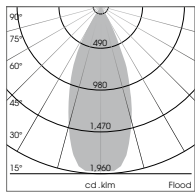

Luminaire luminous flux [lm]
Luminous efficacy [lm/W]

23 W	34 W	41 W	47 W
1,700	2,270	2,900	3,240
73	66	71	69

Illuminance [lx]

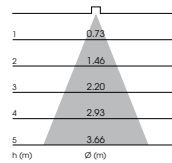

h (m)	Ø (m)	23 W	34 W	41 W	47 W
1	0.73	3,376	4,507	5,610	6,268
2	1.46	844	1,127	1,403	1,567
3	2.20	375	501	623	696
4	2.93	211	282	351	392
5	3.66	135	180	224	251

OVALBASIC

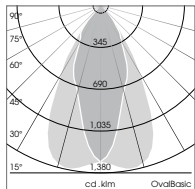

Luminaire luminous flux [lm]
Luminous efficacy [lm/W]

23 W	34 W	41 W	47 W
1,700	2,270	2,900	3,240
73	66	71	69

Illuminance [lx]

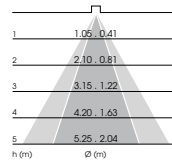

h (m)	Ø (m)	23 W	34 W	41 W	47 W
1	1.05	2,647	3,535	3,740	4,178
2	2.10	662	884	935	1,045
3	3.15	294	393	416	464
4	4.20	165	221	234	261
5	5.25	106	141	150	167

SpecialMeat

Colour spectrum

SpecialMeat is the special light colour for the illumination of fresh meat and cold cuts and can be viewed as a modern LED successor to the proven SDW-T/ patented filter variant. The LED spectrum with a correlated colour temperature of 1,900 K is a product-specific special light colour.

REFLECTORS

WATTAGES

23 W 34 W 41 W 47 W

SPOT

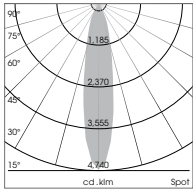

Luminaire luminous flux [lm]
Luminous efficacy [lm/W]

1,440 1,920 2,260 2,490
62 56 55 52

Illuminance [lx]

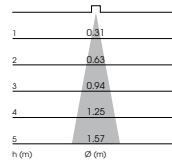

	23 W	34 W	41 W	47 W
1	8,697	11,596	13,649	15,038
2	2,174	2,899	3,412	3,760
3	966	1,288	1,517	1,671
4	544	725	853	940
5	348	464	546	602

FLOOD

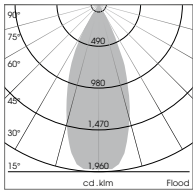

Luminaire luminous flux [lm]
Luminous efficacy [lm/W]

1,440 1,920 2,260 2,490
62 56 55 52

Illuminance [lx]

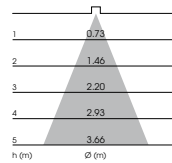

	23 W	34 W	41 W	47 W
1	2,859	3,812	4,487	4,944
2	715	953	1,122	1,236
3	318	424	499	549
4	179	238	280	309
5	114	152	179	198

OVALBASIC

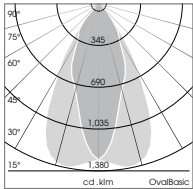

Luminaire luminous flux [lm]
Luminous efficacy [lm/W]

1,440 1,920 2,260 2,490
62 56 55 52

Illuminance [lx]

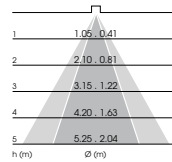

	23 W	34 W	41 W	47 W
1	2,242	2,990	3,519	3,877
2	561	747	880	969
3	249	332	391	431
4	140	187	220	242
5	90	120	141	155

For more technical details about the individual luminaires, please see our datasheets available at www.baero.com. The luminaire luminous flux figures vary in a tolerance range of ± 10%. All data are typical values. System features may change if product improvements are made due to technical advances. Errors excepted.

Special light distribution

BatWing

BatWing reflectors are characterised by a double asymmetrical light distribution pattern with high vertical illuminances and are first and foremost designed for illuminating aisles.

COLOUR CODE

	927	830	835	840
System wattage [W]	59.78	59.78	59.78	59.78
Luminaire luminous flux 2 x 25° [lm]	5,460 . 7,470	6,910 . 9,450	7,040 . 9,650	7,120 . 9,750
Luminaire luminous flux 2 x 35° [lm]	5,340 . 7,310	6,750 . 9,240	6,890 . 9,430	6,960 . 9,530

SAMPLE DISTRIBUTION OF ILLUMINANCE (LX) ON A SHELF FRONT

2 x 25°

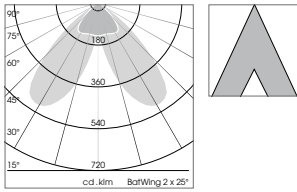

Shelf height [m]	2.20
Number of luminaires	4
Distance to illuminated surface [m]	0.90
Distance between luminaires [m]	2.00
Mounting height [m]	3.50



488	641	457	638	493
531	541	523	552	524
411	392	432	402	422

835 . 59W . 7,040 lm . 119 lm/W

2 x 35°

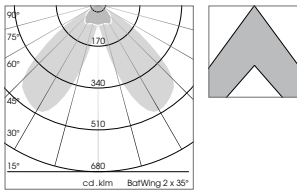

Shelf height [m]	1.80
Number of luminaires	4
Distance to illuminated surface [m]	0.90
Distance between luminaires [m]	2.00
Mounting height [m]	2.80



860	1,060	859	1,070	847
577	554	590	553	576
340	322	353	321	339

835 . 59W . 6,890 lm . 117 lm/W

For more technical details about the individual luminaires, please see our datasheets available at www.baero.com. The luminaire luminous flux figures vary in a tolerance range of ± 10%. All data are typical values. System features may change if product improvements are made due to technical advances. Errors excepted.

Ontero EC 125

Surface-mounted luminaire

REFLECTOR	COL	927	830	835	840	PEARL WHITE	BECOLOR	BECOOL	GOLDEN BREAD	SUN	FISH& SEAFOOD	SPECIAL MEAT
23 W												
Spot	■	21020063	21020014	21020015	21020016	21020119	-	-	21020120	21020171	21020116	21020117
20°	■	21020067	21020018	21020019	21020020	21020124	-	-	21020125	21020172	21020121	21020122
	□	21020071	21020022	21020023	21020024	21020129	-	-	21020130	21020173	21020126	21020127
Flood	■	21000063	21000014	21000015	21000016	21000119	-	-	21000120	21000171	21000116	21000117
40°	■	21000067	21000018	21000019	21000020	21000124	-	-	21000125	21000172	21000121	21000122
	□	21000071	21000022	21000023	21000024	21000129	-	-	21000130	21000173	21000126	21000127
OvalBasic	■	21010063	21010014	21010015	21010016	21010119	-	-	21010120	21010171	21010116	21010117
25° x 55°	■	21010067	21010018	21010019	21010020	21010124	-	-	21010125	21010172	21010121	21010122
	□	21010071	21010022	21010023	21010024	21010129	-	-	21010130	21010173	21010126	21010127
23 W DALI												
Spot	■	21110063	21110014	21110015	21110016	21110119	-	-	21110120	21110171	21110116	21110117
20°	■	21110067	21110018	21110019	21110020	21110124	-	-	21110125	21110172	21110121	21110122
	□	21110071	21110022	21110023	21110024	21110129	-	-	21110130	21110173	21110126	21110127
Flood	■	21090063	21090014	21090015	21090016	21090119	-	-	21090120	21090171	21090116	21090117
40°	■	21090067	21090018	21090019	21090020	21090124	-	-	21090125	21090172	21090121	21090122
	□	21090071	21090022	21090023	21090024	21090129	-	-	21090130	21090173	21090126	21090127
OvalBasic	■	21100063	21100014	21100015	21100016	21100119	-	-	21100120	21100171	21100116	21100117
25° x 55°	■	21100067	21100018	21100019	21100020	21100124	-	-	21100125	21100172	21100121	21100122
	□	21100071	21100022	21100023	21100024	21100129	-	-	21100130	21100173	21100126	21100127
34 W												
Spot	■	21020087	21020038	21020039	21020040	21020149	-	-	21020150	21020174	21020146	21020147
20°	■	21020091	21020042	21020043	21020044	21020154	-	-	21020155	21020175	21020151	21020152
	□	21020095	21020046	21020047	21020048	21020159	-	-	21020160	21020176	21020156	21020157
Flood	■	21000087	21000038	21000039	21000040	21000149	-	-	21000150	21000174	21000146	21000147
40°	■	21000091	21000042	21000043	21000044	21000154	-	-	21000155	21000175	21000151	21000152
	□	21000095	21000046	21000047	21000048	21000159	-	-	21000160	21000176	21000156	21000157
OvalBasic	■	21010087	21010038	21010039	21010040	21010149	-	-	21010150	21010174	21010146	21010147
25° x 55°	■	21010091	21010042	21010043	21010044	21010154	-	-	21010155	21010175	21010151	21010152
	□	21010095	21010046	21010047	21010048	21010159	-	-	21010160	21010176	21010156	21010157
34 W DALI												
Spot	■	21110087	21110038	21110039	21110040	21110149	-	-	21110150	21110174	21110146	21110147
20°	■	21110091	21110042	21110043	21110044	21110154	-	-	21110155	21110175	21110151	21110152
	□	21110095	21110046	21110047	21110048	21110159	-	-	21110160	21110176	21110156	21110157
Flood	■	21090087	21090038	21090039	21090040	21090149	-	-	21090150	21090174	21090146	21090147
40°	■	21090091	21090042	21090043	21090044	21090154	-	-	21090155	21090175	21090151	21090152
	□	21090095	21090046	21090047	21090048	21090159	-	-	21090160	21090176	21090156	21090157
OvalBasic	■	21100087	21100038	21100039	21100040	21100149	-	-	21100150	21100174	21100146	21100147
25° x 55°	■	21100091	21100042	21100043	21100044	21100154	-	-	21100155	21100175	21100151	21100152
	□	21100095	21100046	21100047	21100048	21100159	-	-	21100160	21100176	21100156	21100157
41 W												
Spot	■	21080051	21080002	21080003	21080004	21080104	-	-	21080105	21080171	21080101	21080102
20°	■	21080055	21080006	21080007	21080008	21080109	-	-	21080110	21080172	21080106	21080107
	□	21080059	21080010	21080011	21080012	21080114	-	-	21080115	21080173	21080111	21080112
Flood	■	21060051	21060002	21060003	21060004	21060104	-	-	21060105	21060171	21060101	21060102
40°	■	21060055	21060006	21060007	21060008	21060109	-	-	21060110	21060172	21060106	21060107
	□	21060059	21060010	21060011	21060012	21060114	-	-	21060115	21060173	21060111	21060112
OvalBasic	■	21070051	21070002	21070003	21070004	21070104	-	-	21070105	21070171	21070101	21070102
25° x 55°	■	21070055	21070006	21070007	21070008	21070109	-	-	21070110	21070172	21070106	21070107
	□	21070059	21070010	21070011	21070012	21070114	-	-	21070115	21070173	21070111	21070112
41 W DALI												
Spot	■	21170051	21170002	21170003	21170004	21170104	-	-	21170105	21170171	21170101	21170102
20°	■	21170055	21170006	21170007	21170008	21170109	-	-	21170110	21170172	21170106	21170107
	□	21170059	21170010	21170011	21170012	21170114	-	-	21170115	21170173	21170111	21170112
Flood	■	21150051	21150002	21150003	21150004	21150104	-	-	21150105	21150171	21150101	21150102
40°	■	21150055	21150006	21150007	21150008	21150109	-	-	21150110	21150172	21150106	21150107
	□	21150059	21150010	21150011	21150012	21150114	-	-	21150115	21150173	21150111	21150112
OvalBasic	■	21160051	21160002	21160003	21160004	21160104	-	-	21160105	21160171	21160101	21160102
25° x 55°	■	21160055	21160006	21160007	21160008	21160109	-	-	21160110	21160172	21160106	21160107
	□	21160059	21160010	21160011	21160012	21160114	-	-	21160115	21160173	21160111	21160112

Contact service@baero.com for your personal price information. Please refer to our data sheets at www.baero.com for further technical details on the individual luminaires. All data are typical values. System features may change with product improvements due to technical advances. Errors excepted.

Ontero EC 125

Surface-mounted luminaire

REFLECTOR	COL	927	830	835	840	PEARL WHITE	BECOLOR	BECOO	GOLDEN BREAD	SUN	FISH& SEAFOOD	SPECIAL MEAT
47 W												
Spot	■	21080063	21080014	21080015	21080016	21080119	-	-	21080120	21080174	21080116	21080117
20°	■	21080067	21080018	21080019	21080020	21080124	-	-	21080125	21080175	21080121	21080122
	□	21080071	21080022	21080023	21080024	21080129	-	-	21080130	21080176	21080126	21080127
Flood	■	21060063	21060014	21060015	21060016	21060119	-	-	21060120	21060174	21060116	21060117
40°	■	21060067	21060018	21060019	21060020	21060124	-	-	21060125	21060175	21060121	21060122
	□	21060071	21060022	21060023	21060024	21060129	-	-	21060130	21060176	21060126	21060127
OvalBasic	■	21070063	21070014	21070015	21070016	21070119	-	-	21070120	21070174	21070116	21070117
25° x 55°	■	21070067	21070018	21070019	21070020	21070124	-	-	21070125	21070175	21070121	21070122
	□	21070071	21070022	21070023	21070024	21070129	-	-	21070130	21070176	21070126	21070127
47 W DALI												
Spot	■	21170063	21170014	21170015	21170016	21170119	-	-	21170120	21170174	21170116	21170117
20°	■	21170067	21170018	21170019	21170020	21170124	-	-	21170125	21170175	21170121	21170122
	□	21170071	21170022	21170023	21170024	21170129	-	-	21170130	21170176	21170126	21170127
Flood	■	21150063	21150014	21150015	21150016	21150119	-	-	21150120	21150174	21150116	21150117
40°	■	21150067	21150018	21150019	21150020	21150124	-	-	21150125	21150175	21150121	21150122
	□	21150071	21150022	21150023	21150024	21150129	-	-	21150130	21150176	21150126	21150127
OvalBasic	■	21160063	21160014	21160015	21160016	21160119	-	-	21160120	21160174	21160116	21160117
25° x 55°	■	21160067	21160018	21160019	21160020	21160124	-	-	21160125	21160175	21160121	21160122
	□	21160071	21160022	21160023	21160024	21160129	-	-	21160130	21160176	21160126	21160127
59 W												
BatWing	■	21360004	21360001	21360002	21360003	-	-	-	-	-	-	-
2 x 25°	■	21360008	21360005	21360006	21360007	-	-	-	-	-	-	-
	□	21360012	21360009	21360010	21360011	-	-	-	-	-	-	-
BatWing	■	21360016	21360013	21360014	21360015	-	-	-	-	-	-	-
2 x 35°	■	21360020	21360017	21360018	21360019	-	-	-	-	-	-	-
	□	21360024	21360021	21360022	21360023	-	-	-	-	-	-	-
78 W												
BatWing	■	21350004	21350001	21350002	21350003	-	-	-	-	-	-	-
2 x 25°	■	21350008	21350005	21350006	21350007	-	-	-	-	-	-	-
	□	21350012	21350009	21350010	21350011	-	-	-	-	-	-	-
BatWing	■	21350016	21350013	21350014	21350015	-	-	-	-	-	-	-
2 x 35°	■	21350020	21350017	21350018	21350019	-	-	-	-	-	-	-
	□	21350024	21350021	21350022	21350023	-	-	-	-	-	-	-
FRONT RING												
chrome, incl. bayonet ring		40020018										

Contact service@baero.com for your personal price information. Please refer to our data sheets at www.baero.com for further technical details on the individual luminaires. All data are typical values. System features may change with product improvements due to technical advances. Errors excepted.

Intara EC 125

Semi-recessed luminaire

The separate driver unit is supplied with a feed-through wiring set. The luminaire is also available as a DALI version for integration in a light control system.

REFLECTOR	COL	927	830	835	840	PEARL WHITE	BECOLOR	BECOOOL	GOLDEN BREAD	SUN	FISH& SEAFOOD	SPECIAL MEAT
23 W / 34 W												
Spot	■	51200051	51200002	51200003	51200004	51200104	-	-	51200105	51200171	51200101	51200102
20°	■	51200055	51200006	51200007	51200008	51200109	-	-	51200110	51200172	51200106	51200107
	□	51200059	51200010	51200011	51200012	51200114	-	-	51200115	51200173	51200111	51200112
Flood	■	51180051	51180002	51180003	51180004	51180104	-	-	51180105	51180171	51180101	51180102
40°	■	51180055	51180006	51180007	51180008	51180109	-	-	51180110	51180172	51180106	51180107
	□	51180059	51180010	51180011	51180012	51180114	-	-	51180115	51180173	51180111	51180112
OvalBasic	■	51190051	51190002	51190003	51190004	51190104	-	-	51190105	51190171	51190101	51190102
25° x 55°	■	51190055	51190006	51190007	51190008	51190109	-	-	51190110	51190172	51190106	51190107
	□	51190059	51190010	51190011	51190012	51190114	-	-	51190115	51190173	51190111	51190112
41 W / 47 W												
Spot	■	51230051	51230002	51230003	51230004	51230104	-	-	51230105	51230171	51230101	51230102
20°	■	51230055	51230006	51230007	51230008	51230109	-	-	51230110	51230172	51230106	51230107
	□	51230059	51230010	51230011	51230012	51230114	-	-	51230115	51230173	51230111	51230112
Flood	■	51210051	51210002	51210003	51210004	51210104	-	-	51210105	51210171	51210101	51210102
40°	■	51210055	51210006	51210007	51210008	51210109	-	-	51210110	51210172	51210106	51210107
	□	51210059	51210010	51210011	51210012	51210114	-	-	51210115	51210173	51210111	51210112
OvalBasic	■	51220051	51220002	51220003	51220004	51220104	-	-	51220105	51220171	51220101	51220102
25° x 55°	■	51220055	51220006	51220007	51220008	51220109	-	-	51220110	51220172	51220106	51220107
	□	51220059	51220010	51220011	51220012	51220114	-	-	51220115	51220173	51220111	51220112
FRONT RING												
chrome, incl. bayonet ring		40020018										
DRIVER UNIT												
Constant current		76500034	[600 mA / 23 Watt]									
		76500076	[850 mA / 34 Watt]									
		76500037	[1,050 mA / 41 Watt]									
		76500092	[1,200 mA / 47 Watt]									
DALI		76500039	[600 mA / 23 Watt]									
		76500077	[850 mA / 34 Watt]									
		76500042	[1,050 mA / 41 Watt]									
		76500093	[1,200 mA / 47 Watt]									

The driver units must be ordered separately.

Pendiro EC 125

Suspended luminaire

The separate driver unit is included in the scope of supply for the variant for ceiling installation and is supplied with a through-wiring set. When placing your order please state the product number with the desired power output.

REFLECTOR	COL	927	830	835	840	PEARL WHITE	BECOLOR	BECOOL	GOLDEN BREAD	SUN	FISH& SEAFOOD	SPECIAL MEAT
23 WTRACK												
Spot	■	81020063	81020014	81020015	81020016	81020119	-	-	81020120	81020171	81020116	81020117
20°	■	81020067	81020018	81020019	81020020	81020124	-	-	81020125	81020172	81020121	81020122
	□	81020071	81020022	81020023	81020024	81020129	-	-	81020130	81020173	81020126	81020127
Flood	■	81000063	81000014	81000015	81000016	81000119	-	-	81000120	81000171	81000116	81000117
40°	■	81000067	81000018	81000019	81000020	81000124	-	-	81000125	81000172	81000121	81000122
	□	81000071	81000022	81000023	81000024	81000129	-	-	81000130	81000173	81000126	81000127
OvalBasic	■	81010063	81010014	81010015	81010016	81010119	-	-	81010120	81010171	81010116	81010117
25° x 55°	■	81010067	81010018	81010019	81010020	81010124	-	-	81010125	81010172	81010121	81010122
	□	81010071	81010022	81010023	81010024	81010129	-	-	81010130	81010173	81010126	81010127
23 W CEILING MOUNTING												
Spot	■	81050063	81050014	81050015	81050016	81050119	-	-	81050120	81050171	81050116	81050117
20°	■	81050067	81050018	81050019	81050020	81050124	-	-	81050125	81050172	81050121	81050122
	□	81050071	81050022	81050023	81050024	81050129	-	-	81050130	81050173	81050126	81050127
Flood	■	81030063	81030014	81030015	81030016	81030119	-	-	81030120	81030171	81030116	81030117
40°	■	81030067	81030018	81030019	81030020	81030124	-	-	81030125	81030172	81030121	81030122
	□	81030071	81030022	81030023	81030024	81030129	-	-	81030130	81030173	81030126	81030127
OvalBasic	■	81040063	81040014	81040015	81040016	81040119	-	-	81040120	81040171	81040116	81040117
25° x 55°	■	81040067	81040018	81040019	81040020	81040124	-	-	81040125	81040172	81040121	81040122
	□	81040071	81040022	81040023	81040024	81040129	-	-	81040130	81040173	81040126	81040127
23 W / 34 W CEILING INSTALLATION												
Spot	■	81080051	81080002	81080003	81080004	81080107	-	-	81080105	81080171	81080101	81080102
20°	■	81080055	81080006	81080007	81080008	81080112	-	-	81080110	81080172	81080106	81080107
	□	81080059	81080010	81080011	81080012	81080117	-	-	81080115	81080173	81080111	81080112
Flood	■	81060051	81060002	81060003	81060004	81060107	-	-	81060105	81060171	81060101	81060102
40°	■	81060055	81060006	81060007	81060008	81060112	-	-	81060110	81060172	81060106	81060107
	□	81060059	81060010	81060011	81060012	81060117	-	-	81060115	81060173	81060111	81060112
OvalBasic	■	81070051	81070002	81070003	81070004	81070107	-	-	81070105	81070171	81070101	81070102
25° x 55°	■	81070055	81070006	81070007	81070008	81070112	-	-	81070110	81070172	81070106	81070107
	□	81070059	81070010	81070011	81070012	81070117	-	-	81070115	81070173	81070111	81070112
34 WTRACK												
Spot	■	81020087	81020038	81020039	81020040	81020149	-	-	81020150	81020174	81020146	81020147
20°	■	81020091	81020042	81020043	81020044	81020154	-	-	81020155	81020175	81020151	81020152
	□	81020095	81020046	81020047	81020048	81020159	-	-	81020160	81020176	81020156	81020157
Flood	■	81000087	81000038	81000039	81000040	81000149	-	-	81000150	81000174	81000146	81000147
40°	■	81000091	81000042	81000043	81000044	81000154	-	-	81000155	81000175	81000151	81000152
	□	81000095	81000046	81000047	81000048	81000159	-	-	81000160	81000176	81000156	81000157
OvalBasic	■	81010087	81010038	81010039	81010040	81010149	-	-	81010150	81010174	81010146	81010147
25° x 55°	■	81010091	81010042	81010043	81010044	81010154	-	-	81010155	81010175	81010151	81010152
	□	81010095	81010046	81010047	81010048	81010159	-	-	81010160	81010176	81010156	81010157
34 W CEILING MOUNTING												
Spot	■	81050087	81050038	81050039	81050040	81050149	-	-	81050150	81050174	81050146	81050147
20°	■	81050091	81050042	81050043	81050044	81050154	-	-	81050155	81050175	81050151	81050152
	□	81050095	81050046	81050047	81050048	81050159	-	-	81050160	81050176	81050156	81050157
Flood	■	81030087	81030038	81030039	81030040	81030149	-	-	81030150	81030174	81030146	81030147
40°	■	81030091	81030042	81030043	81030044	81030154	-	-	81030155	81030175	81030151	81030152
	□	81030095	81030046	81030047	81030048	81030159	-	-	81030160	81030176	81030156	81030157
OvalBasic	■	81040087	81040038	81040039	81040040	81040149	-	-	81040150	81040174	81040146	81040147
25° x 55°	■	81040091	81040042	81040043	81040044	81040154	-	-	81040155	81040175	81040151	81040152
	□	81040095	81040046	81040047	81040048	81040159	-	-	81040160	81040176	81040156	81040157

Pendiro EC 125

Suspended luminaire

The separate driver unit is included in the scope of supply for the variant for ceiling installation and is supplied with a through-wiring set. When placing your order please state the product number with the desired power output.

REFLECTOR	COL	927	830	835	840	PEARL WHITE	BECOLOR	BECOO	GOLDEN BREAD	SUN	FISH& SEAFOOD	SPECIAL MEAT
41 W TRACK												
Spot	■	81020251	81020202	81020203	81020204	81020304	-	-	81020305	81020177	81020301	81020302
20°	■	81020255	81020206	81020207	81020208	81020309	-	-	81020310	81020178	81020306	81020307
	□	81020259	81020210	81020211	81020212	81020314	-	-	81020315	81020179	81020311	81020312
Flood	■	81000251	81000202	81000203	81000204	81000304	-	-	81000305	81000177	81000301	81000302
40°	■	81000255	81000206	81000207	81000208	81000309	-	-	81000310	81000178	81000306	81000307
	□	81000259	81000210	81000211	81000212	81000314	-	-	81000315	81000179	81000311	81000312
OvalBasic	■	81010251	81010202	81010203	81010204	81010304	-	-	81010305	81010177	81010301	81010302
25° x 55°	■	81010255	81010206	81010207	81010208	81010309	-	-	81010310	81010178	81010306	81010307
	□	81010259	81010210	81010211	81010212	81010314	-	-	81010315	81010179	81010311	81010312
41 W CEILING MOUNTING												
Spot	■	81050251	81050202	81050203	81050204	81050304	-	-	81050305	81050177	81050301	81050302
20°	■	81050255	81050206	81050207	81050208	81050309	-	-	81050310	81050178	81050306	81050307
	□	81050259	81050210	81050211	81050212	81050314	-	-	81050315	81050179	81050311	81050312
Flood	■	81030251	81030202	81030203	81030204	81030304	-	-	81030305	81030177	81030301	81030302
40°	■	81030255	81030206	81030207	81030208	81030309	-	-	81030310	81030178	81030306	81030307
	□	81030259	81030210	81030211	81030212	81030314	-	-	81030315	81030179	81030311	81030312
OvalBasic	■	81040251	81040202	81040203	81040204	81040304	-	-	81040305	81040177	81040301	81040302
25° x 55°	■	81040255	81040206	81040207	81040208	81040309	-	-	81040310	81040178	81040306	81040307
	□	81040259	81040210	81040211	81040212	81040314	-	-	81040315	81040179	81040311	81040312
41 W CEILING INSTALLATION												
Spot	■	81080251	81080202	81080203	81080204	81080304	-	-	81080305	81080174	81080301	81080302
20°	■	81080255	81080206	81080207	81080208	81080309	-	-	81080310	81080175	81080306	81080307
	□	81080259	81080210	81080211	81080212	81080314	-	-	81080315	81080176	81080311	81080312
Flood	■	81060251	81060202	81060203	81060204	81060304	-	-	81060305	81060174	81060301	81060302
40°	■	81060255	81060206	81060207	81060208	81060309	-	-	81060310	81060175	81060306	81060307
	□	81060259	81060210	81060211	81060212	81060314	-	-	81060315	81060176	81060311	81060312
OvalBasic	■	81070251	81070202	81070203	81070204	81070304	-	-	81070305	81070174	81070301	81070302
25° x 55°	■	81070255	81070206	81070207	81070208	81070309	-	-	81070310	81070175	81070306	81070307
	□	81070259	81070210	81070211	81070212	81070314	-	-	81070315	81070176	81070311	81070312
FRONT RING												
chrome, incl. bayonet ring		40020018										
DRIVER UNIT FOR CEILING INSTALLATION												
Constant current		76500034	[600 mA / 23 Watt]									
		76500076	[850 mA / 34 Watt]									
		76500037	[1,050 mA / 41 Watt]									
DALI		76500039	[600 mA / 23 Watt]									
		76500077	[850 mA / 34 Watt]									
		76500042	[1,050 mA / 41 Watt]									

The driver units for ceiling installation must be ordered separately.



BÄRO – Your lighting partner. Right from the start.

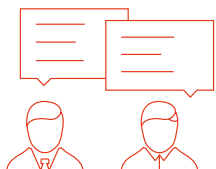

> ADVICE Discover the potential.

A fundamental aspect of our advice is to convey to all those involved in the project the huge potential and the many nuanced possibilities of expression offered by the medium light today thanks to LED technology. Talk to our lighting consultants and find out about the impact that BÄRO products can have in your store – not just in view of effectiveness and efficiency, but also and especially in terms of the emotionality of light.



> PLANNING Light that suits you.

Light can be designed in many different qualities and dimensions. Sophisticated light planning not only supports the dramaturgy of the shopping experience; it also allows the lighting to be perfectly tailored to the different visual tasks and product groups. We are committed to finding a customised, expressive light balance for every concept – through the interplay of light distribution and light channelling, light intensities and light colours.

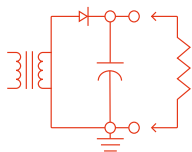

> INSTALLATION On site together.

Careful and professional installation is just as important as effective and creative lighting planning. BÄRO supports you in the installation and alignment of luminaires on site – so that your customised lighting concept rapidly takes shape and unforeseen issues are quickly resolved. In this way you can be sure that the lighting is perfectly focused on the room and the products.

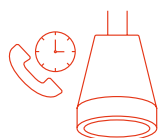

> SUPPORT Long-term cooperation.

Our products boast long-lasting quality and functionality. Nonetheless, our service does not end when your lighting system is put into operation. BÄRO is available to answer your questions and provide services even after completion of the project.



> LEASING Efficient lighting. Financed effectively.

Customised financing for a customised lighting concept. Whether you are a retailer or a retail brand, we will be pleased to advise you on a leasing concept that suits your specific needs. Together we will draw up a contract that caters to your wishes and the needs of your company. Contact us. We're pleased to assist you.

> CONTACT

Tel.: +49 800 799 1000/e-mail: service@baero.com

Concept and Art Direction:
Meiré und Meiré, Köln
www.meireundmeire.de

Photography:
Hartmut Nägele
Stephan Abry
Elmar Botschen

BÄRO GmbH & Co. KG
Wolfstall 54-56
42799 Leichlingen

T +49 2174 799 0
F +49 2174 799 799
www.baero.com